



**Bonfiglioli**  
Tecnoingranaggi

---

## LC series

Low-backlash gearboxes



**Bonfiglioli**

power, control and green solutions



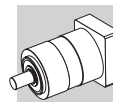

## SUMMARY



<b>1 General information</b> .....	3
1.1 Symbols, units and definitions .....	3
1.2 Selecting the gear unit .....	4
1.3 Service life of bearings .....	6
<b>2 Features of LC series</b> .....	8
<b>3 Ordering code</b> .....	9
<b>4 Dimensions and technical specifications</b> .....	10
LC 050 .....	10
LC 070 .....	12
LC 090 .....	14
LC 120 .....	16
LC 155 .....	18

### Revisions

Refer to page 20 for the catalogue revision index.

Visit [www.bonfiglioli.com](http://www.bonfiglioli.com) to search for catalogues with up-to-date revisions.

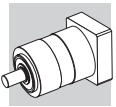

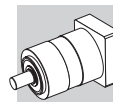

## 1 GENERAL INFORMATION

### 1.1 SYMBOLS, UNITS AND DEFINITIONS

#### Values depending on the **APPLICATION**

term	u.m.	definition
<b>A<sub>2</sub></b>	[N]	Thrust force on output shaft
<b>A<sub>2</sub> EQU</b>	[N]	Equivalent thrust force applying on output shaft
<b>A<sub>2</sub> MAX</b>	[N]	Maximum thrust force applying on output shaft
<b>R<sub>2</sub></b>	[N]	Radial force on output shaft
<b>R<sub>2</sub> EQU</b>	[N]	Equivalent radial force applying on output shaft
<b>R<sub>2</sub> MAX</b>	[N]	Maximum radial force applying on output shaft
<b>ED</b>	[min]	Loading time
<b>ED%</b>	[%]	Loading time %
<b>L<sub>10h</sub> TARGET</b>	[h]	Output shaft bearings' desired basic rating life
<b>M<sub>1</sub> PEAK</b>	[Nm]	Maximum input torque (usually motor)
<b>M<sub>2(1) ... M<sub>2(n)</sub></sub></b>	[Nm]	Output torque at each of the time periods t <sub>1</sub> ... t <sub>n</sub>
<b>M<sub>2</sub> EQU</b>	[Nm]	Equivalent output torque
<b>M<sub>2</sub> MAX</b>	[Nm]	Maximum output torque in case of emergency
<b>M<sub>T2</sub> EQU</b>	[Nm]	Equivalent tilting moment applying on output shaft
<b>M<sub>T2</sub> MAX</b>	[Nm]	Maximum tilting moment applying on output shaft
<b>n<sub>2</sub></b>	[min <sup>-1</sup> ]	Output speed
<b>n<sub>2(1) ... n<sub>2(n)</sub></sub></b>	[min <sup>-1</sup> ]	Output speed based on the time periods t <sub>1</sub> ... t <sub>n</sub>
<b>n<sub>2</sub> EQU</b>	[min <sup>-1</sup> ]	Equivalent output speed
<b>n<sub>2</sub> MAX</b>	[min <sup>-1</sup> ]	Maximum output speed
<b>T</b>	[C°]	Ambient temperature
<b>t<sub>1</sub> ... t<sub>n</sub></b>	[s]	Time periods of motion
<b>t<sub>Σ</sub></b>	[s]	Cycle duration including pause
<b>Z</b>	[1/h]	Cycle number per hour

#### Values depending on the **GEAR DRIVE SELECTION**

term	u.m.	definition
<b>A<sub>2 3</sub> max</b>	[N]	Admissible thrust force on output shaft
<b>A<sub>2'</sub> max</b>	[N]	Thrust force acting simultaneously with the rated radial force
<b>R<sub>1</sub> max</b>	[N]	Admissible radial force at midpoint of input shaft
<b>R<sub>2 3</sub> max</b>	[N]	Admissible radial force at midpoint of output shaft
<b>C<sub>B</sub></b>	[Nm]	Constant for bearing's lifetime calculation
<b>C<sub>t</sub></b>	$\left[ \frac{\text{Nm}}{\text{arcmin}} \right]$	Torsional stiffness
<b>f<sub>n</sub></b>	—	Speed factor
<b>f<sub>z</sub></b>	—	Cycle factor
<b>f<sub>T</sub></b>	—	Temperature adjusting factor
<b>i</b>	—	Gearbox ratio
<b>J<sub>G</sub></b>	[kgcm <sup>2</sup> ]	Mass moment of inertia of the gearhead
<b>K<sub>n</sub></b>	—	Speed constant
<b>L<sub>10h</sub></b>	[h]	Bearings' basic rating life
<b>L<sub>Z</sub></b>	[mm]	Factor for bearing's lifetime calculation
<b>M<sub>a 2</sub></b>	[Nm]	Maximum acceleration output torque
<b>M<sub>n 2</sub></b>	[Nm]	Rated output torque
<b>M<sub>p 2</sub></b>	[Nm]	Emergency stop output torque
<b>M<sub>T2</sub> max</b>	[Nm]	Maximum tilting moment applying on output shaft
<b>n<sub>1</sub> max</b>	[min <sup>-1</sup> ]	Maximum momentary input speed. The speed the unit can be driven at occasionally and in non-repetitive conditions For cycle duty type S5, it cannot be applied continuously for more than 30 seconds
<b>p</b>	—	Bearing lifetime exponent
<b>η</b>	[%]	Gear efficiency
<b>φ<sub>R</sub></b>	[arcmin]	Reduced backlash is calculated in static conditions and with the application of a torque equal to 2% of the gear unit rated torque
<b>φ<sub>S</sub></b>	[arcmin]	Standard backlash is calculated in static conditions and with the application of a torque equal to 2% of the gear unit rated torque

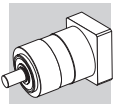

## 1.2 SELECTING THE GEAR UNIT

(a)	Ratio	$i$	—	$i = \frac{n_1}{n_2}$														
(b)	Equivalent output torque	$M_{2\text{ EQU}}$	[Nm]	$M_{2\text{ EQU}} = \sqrt[3]{\frac{n_{2(1)} \cdot t_1 \cdot  M_{2(1)} ^3 + \dots + n_{2(n)} \cdot t_n \cdot  M_{2(n)} ^3}{n_{2(1)} \cdot t_1 + \dots + n_{2(n)} \cdot t_n}}$														
(c)	Equivalent output speed	$n_{2\text{ EQU}}$	[min <sup>-1</sup> ]	$n_{2\text{ EQU}} = \frac{n_{2(1)} \cdot t_1 + n_{2(2)} \cdot t_2 + \dots + n_{2(n)} \cdot t_n}{t_\Sigma}$														
(d)	Speed factor	$f_n$	—	<p>If <math>\frac{K_n}{n_{2\text{ EQU}} \cdot i} \geq 1 \Rightarrow f_n = 1</math></p> <p>If <math>\frac{K_n}{n_{2\text{ EQU}} \cdot i} &lt; 1 \Rightarrow f_n = \text{Obtain from diagram}</math></p>														
(e)	Loading time %	ED%	[%]	$ED\% = \frac{t_1 + t_2 + \dots + t_n}{t_\Sigma} \cdot 100$														
	Loading time	ED	[min]	$ED = t_1 + t_2 + \dots + t_n$														
(f)	Cycle number per hour	Z	[1/h]	$Z = \frac{3600}{t_\Sigma}$														
(g)	Cycle factor	$f_z$	—	<table border="1"> <thead> <tr> <th>Z</th> <th><math>f_z</math></th> </tr> </thead> <tbody> <tr> <td><math>Z \leq 1000</math></td> <td>1.00</td> </tr> <tr> <td><math>1000 &lt; Z \leq 1500</math></td> <td>1.25</td> </tr> <tr> <td><math>1500 &lt; Z \leq 2500</math></td> <td>1.50</td> </tr> <tr> <td><math>2500 &lt; Z \leq 4000</math></td> <td>1.75</td> </tr> <tr> <td><math>4000 &lt; Z \leq 6000</math></td> <td>2.00</td> </tr> <tr> <td><math>Z &gt; 6000</math></td> <td>contact us</td> </tr> </tbody> </table>	Z	$f_z$	$Z \leq 1000$	1.00	$1000 < Z \leq 1500$	1.25	$1500 < Z \leq 2500$	1.50	$2500 < Z \leq 4000$	1.75	$4000 < Z \leq 6000$	2.00	$Z > 6000$	contact us
Z	$f_z$																	
$Z \leq 1000$	1.00																	
$1000 < Z \leq 1500$	1.25																	
$1500 < Z \leq 2500$	1.50																	
$2500 < Z \leq 4000$	1.75																	
$4000 < Z \leq 6000$	2.00																	
$Z > 6000$	contact us																	
(h)	Temperature adjusting factor	$f_T$	—	<p>If <math>T \leq 30^\circ\text{C} \Rightarrow f_T = 1</math></p> <p>If <math>T &gt; 30^\circ\text{C} \Rightarrow f_T = 1 + \frac{T - 30}{100}</math></p>														
(i)	Maximum input torque	$M_{1\text{ PEAK}}$	[Nm]	<p>a) maximum possible application torque</p> <p>b) limited motor torque by inverter</p> <p>c) maximum motor torque</p>														

$K_n$ - speed constant					
$i$	LC 050	LC 070	LC 090	LC 120	LC 155
3	1671	1392	2900	2500	1340
4	2200	1584	2500	2100	876
5	2901	2047	2700	2300	957
7	3700	3032	3500	3000	1229
9	4000	3300	2900	2500	3000
10		4000	4000	3500	2500
12	3300	3300	2900	2500	2100
15	3300	3500	2900	2500	2100
16	3500	3500	3100	2800	3000
20	3500	3700	3200	3000	3000
25	3500	4000	3200	3000	3000
28	3500	3700	3500	3000	3000
30		4000	4000	3500	3000
35	3700	4000	3500	3000	3000
36	4000				
40		4000	4000	3500	3000
45	4000				
50		4000	4000	3500	3000
70		4000	4000	3500	3000
81	4000				
100		4000	4000	3500	3000

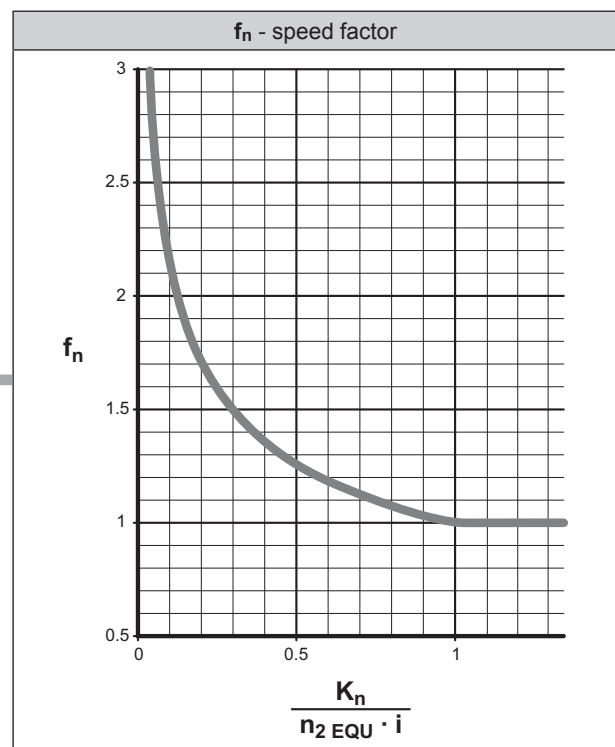

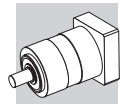

**Load diagram**

—  $M_2$ : Output torque

**Speed diagram**

—  $n_2$ : Output speed

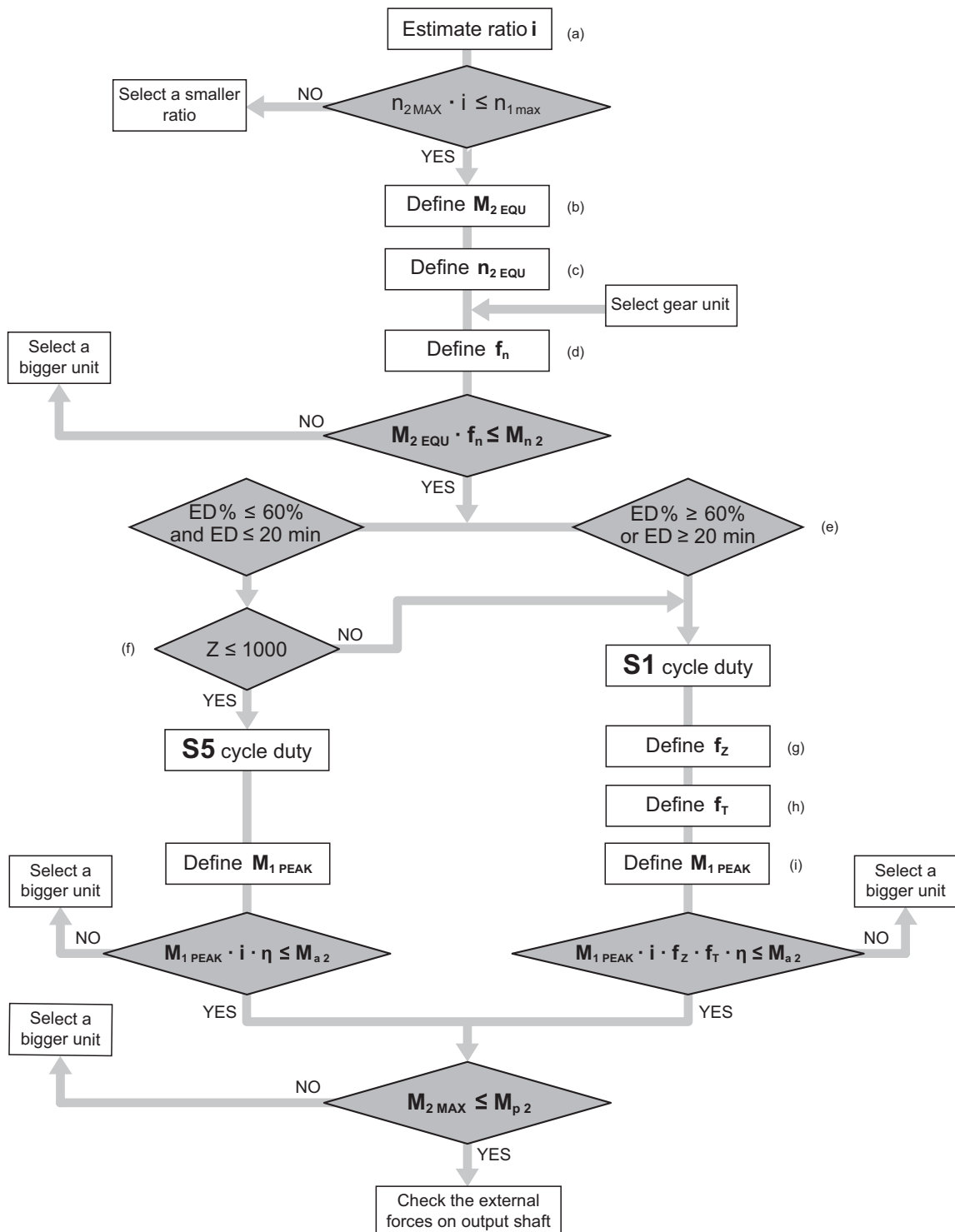
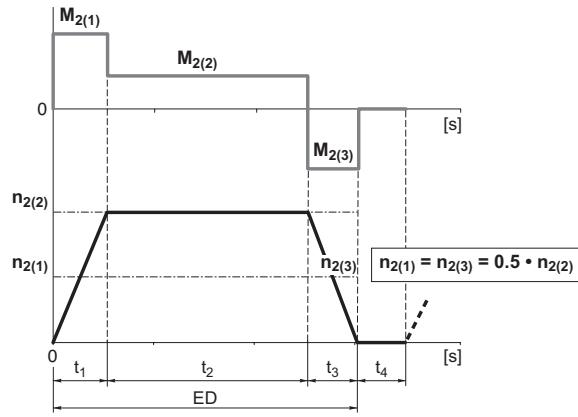

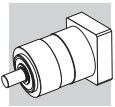

### 1.3 SERVICE LIFE OF BEARINGS

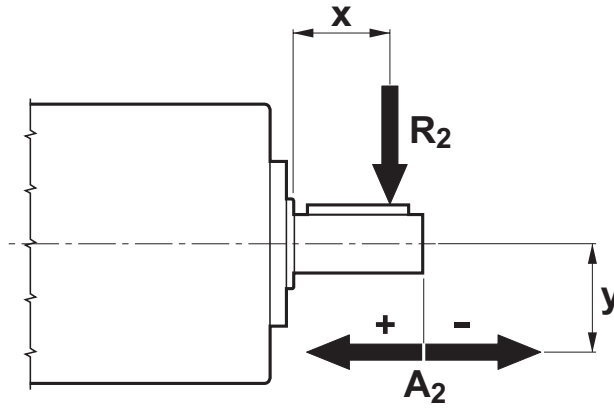

(a)	Maximum radial force applying on output shaft	$R_{2 \text{ MAX}}$	[N]	Please consider the specific conditions (e.g. belt drives under acceleration torque)
	Maximum axial force applying on output shaft	$A_{2 \text{ MAX}}$	[N]	
(b)	Maximum tilting moment applying on output shaft	$M_{T2 \text{ MAX}}$	[Nm]	$M_{T2 \text{ MAX}} = \frac{R_{2 \text{ MAX}} \cdot (x + L_z) \pm A_{2 \text{ MAX}} \cdot y}{1000}$
(c)	Equivalent forces applying on output shaft	$R_{2 \text{ EQU}}$	[N]	$R_{2 \text{ EQU}} = \sqrt[3]{\frac{n_{2(1)} \cdot t_1 \cdot  R_{2(1)} ^3 + \dots + n_{2(n)} \cdot t_n \cdot  R_{2(n)} ^3}{n_{2(1)} \cdot t_1 + \dots + n_{2(n)} \cdot t_n}}$
		$A_{2 \text{ EQU}}$	[N]	$A_{2 \text{ EQU}} = \sqrt[3]{\frac{n_{2(1)} \cdot t_1 \cdot  A_{2(1)} ^3 + \dots + n_{2(n)} \cdot t_n \cdot  A_{2(n)} ^3}{n_{2(1)} \cdot t_1 + \dots + n_{2(n)} \cdot t_n}}$
(d)	Equivalent tilting moment applying on output shaft	$M_{T2 \text{ EQU}}$	[Nm]	$M_{T2 \text{ EQU}} = \frac{R_{2 \text{ EQU}} \cdot (x + L_z) + A_{2 \text{ EQU}} \cdot y}{1000}$
(e)	Equivalent output speed	$n_{2 \text{ EQU}}$	[min <sup>-1</sup> ]	$n_{2 \text{ EQU}} = \frac{n_{2(1)} \cdot t_1 + n_{2(2)} \cdot t_2 + \dots + n_{2(n)} \cdot t_n}{t_1 + t_2 + \dots + t_n}$
(f)	Bearings' basic rating life	$L_{10h}$	[h]	$L_{10h} = \frac{16666}{n_{2 \text{ EQU}}} \cdot \left( \frac{C_B}{M_{T2 \text{ EQU}}} \right)^p$

	LC 050	LC 070	LC 090	LC 120	LC 155
<b>Lz</b> [mm]	22	28	30	39	46
<b>M<sub>T2 max</sub></b> [Nm]	15	54	105	238	522
<b>C<sub>B</sub></b> [Nm]	106	280	298	813	1588
<b>p</b> —	3	3	3	3	3



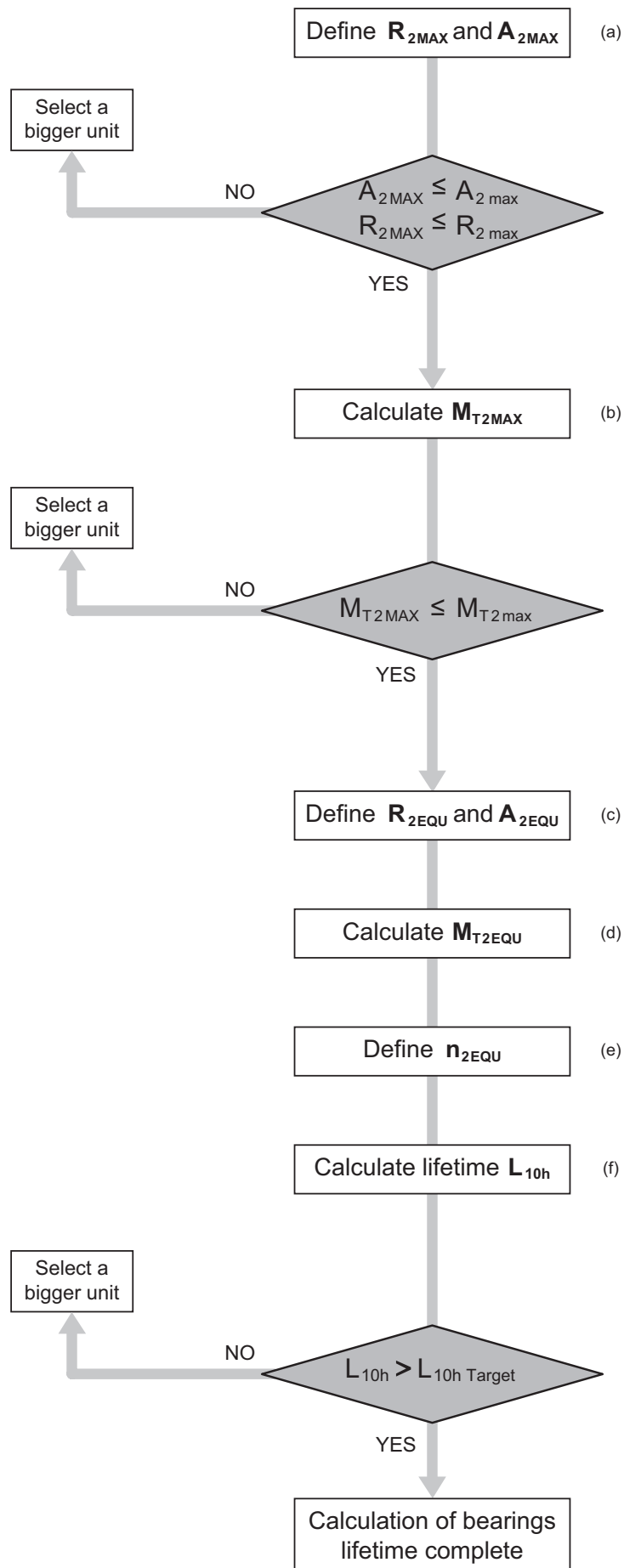
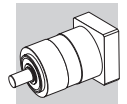

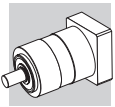

## 2 FEATURES OF LC SERIES

Planetary gear units of the LC series belong to a range of low backlash drives very broad and complete as far as transmissible torque, gear ratios and circumferential backlash.

All units are generously proportioned to run quietly and provide a long service life without maintenance requirements.

Motor mounting is an operation that can be easily conducted without the need of any particular tooling, other than that usually available in a normally equipped workshop.

- Available with either standard (STD) or reduced (LOW) backlash  
single reduction gearheads:  $\varphi_S = 12'$ ;  $\varphi_R = 6'$   
double reduction gearheads:  $\varphi_S = 15'$ ;  $\varphi_R = 8'$
- Ratio  $i = 10$  available for single-reduction units ( $i = 9$  for frame size LC 050 alone)
- Rigid ball bearings, suitably rated for an average service life of 20,000 hours under nominal operating conditions
- Degree of protection IP64
- Oil seals from Viton® compound as standard
- Max. noise level  $L_P \leq 70$  dB(A) @  $n_1 = 3000$  min<sup>-1</sup>
- Wide range of adapter flanges matching the most popular brands of motors
- Units are factory filled with synthetic grease to NLGI consistency class 00, suitable for installation in any mounting position and at ambient temperature within the range 0°C...40°C.  
In the absence of contamination the lubricant does not require periodical changes.

		Distribution of nominal torque $M_{n2}$ [Nm]																				
	[i]	3	4	5	7	9	10	12	15	16	20	25	28	30	35	36	40	45	50	70	81	100
<b>LC 050</b>	10	12	12	12	12	10	-	12	12	12	12	12	12	-	12	12	-	12	-	-	10	-
<b>LC 070</b>	18	25	25	25	25	18	18	25	25	25	25	25	25	18	25	-	25	-	25	25	-	18
<b>LC 090</b>	37	43	43	43	43	37	37	43	43	43	43	43	43	37	43	-	43	-	43	43	-	37
<b>LC 120</b>	95	110	110	110	110	95	95	110	110	110	110	110	110	95	110	-	110	-	110	110	-	95
<b>LC 155</b>	250	300	300	300	300	250	230	300	300	300	300	300	300	250	300	-	300	-	300	300	-	230

■ double reduction gearheads

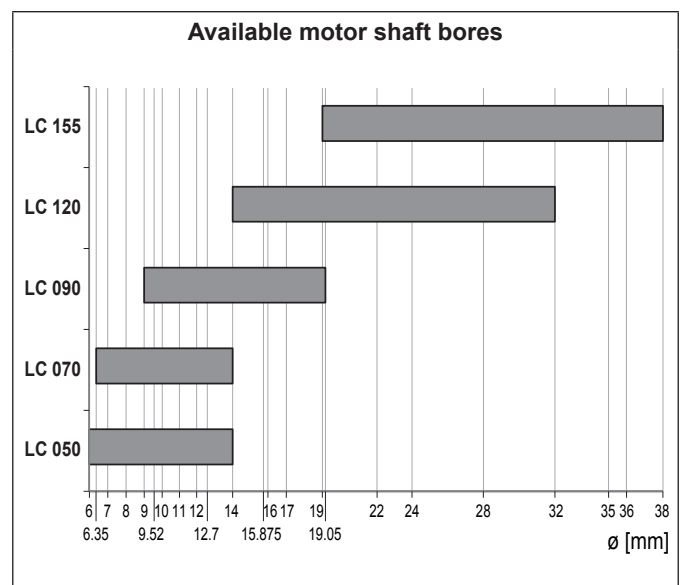
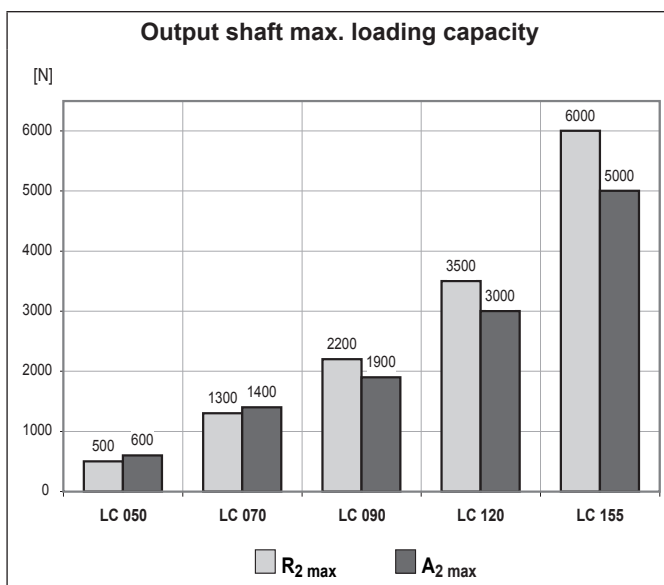

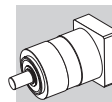

### 3 ORDERING CODE

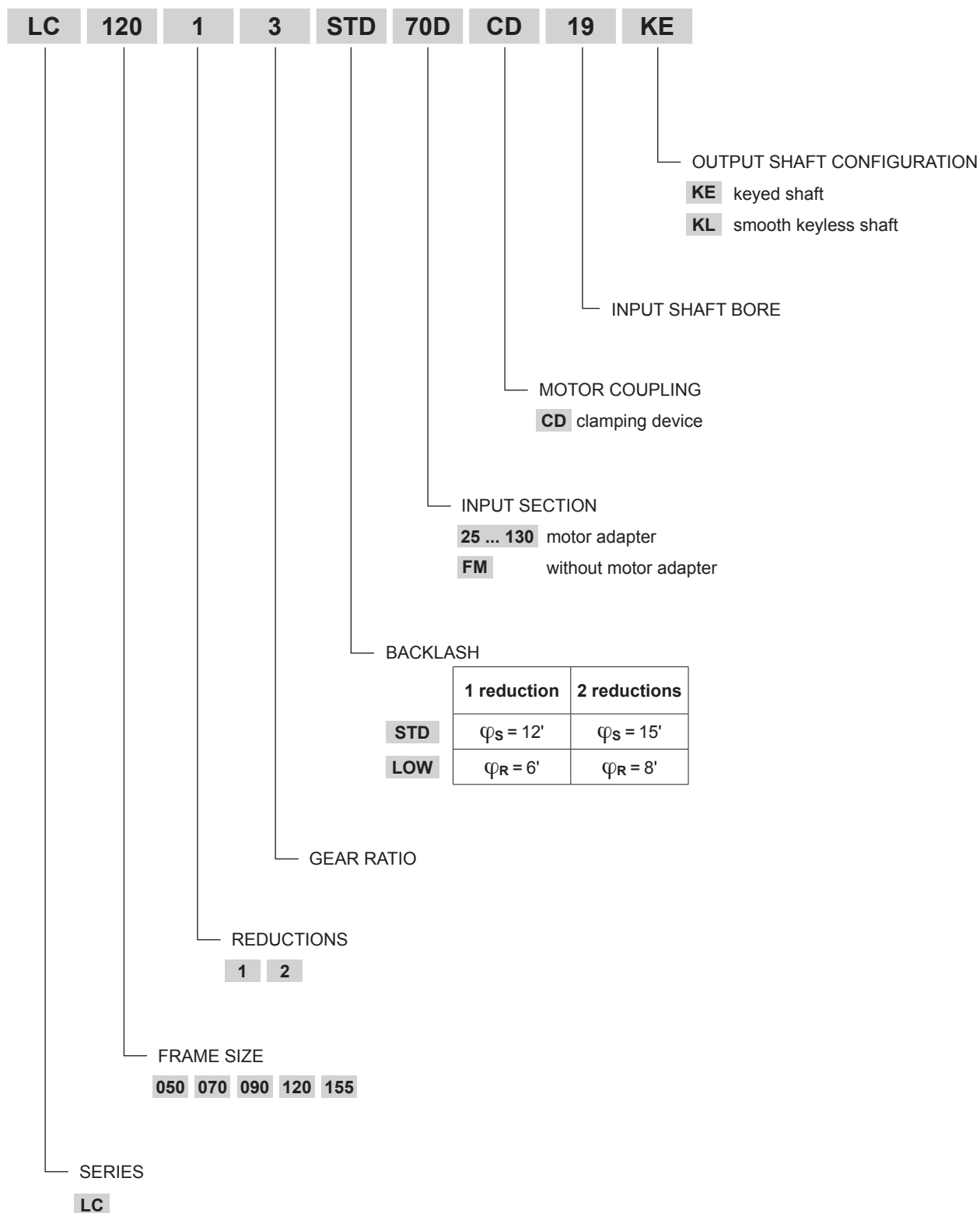

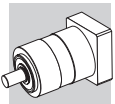

# LC 050

## 4 DIMENSIONS AND TECHNICAL SPECIFICATIONS

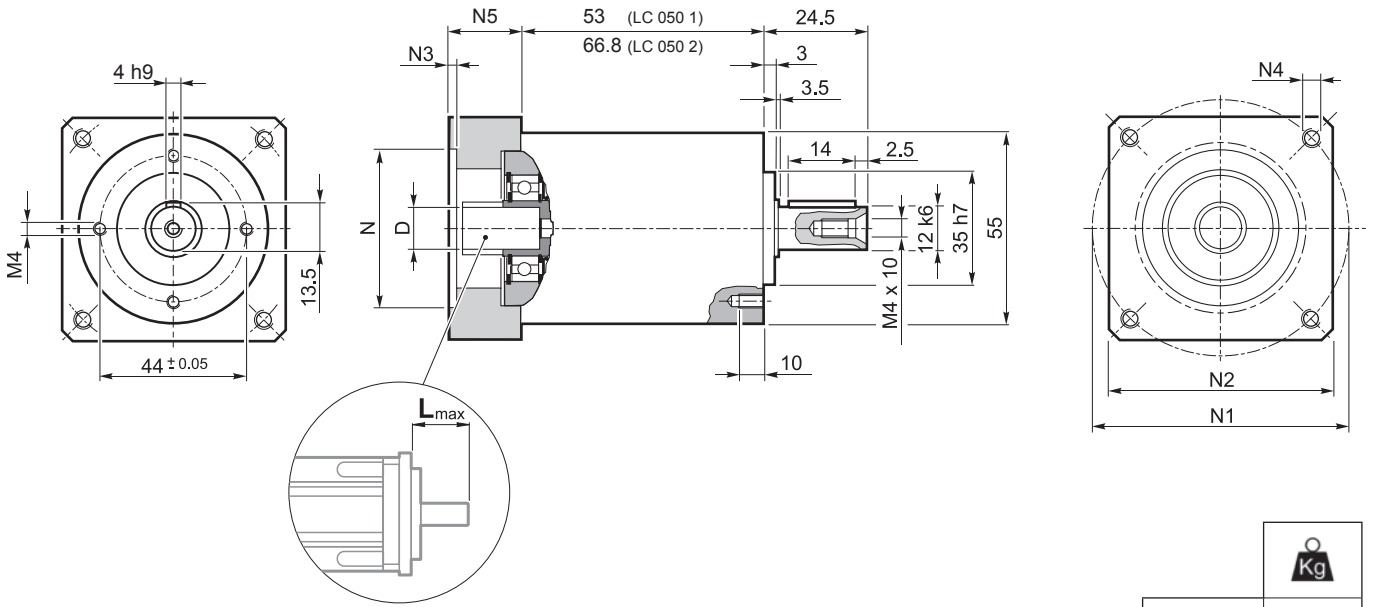

	Kg
LC 050 1	1.1
LC 050 2	1.3

	D	N	N1		N2	N3	N4	N5	L <sub>max</sub>
			min	max					
25AH	6 6.35 7 8 9 9.52 - - - - -	25	36	48					
26AH	6 6.35 7 8 9 9.52 - - - - -	26	36	48					
28AH	6 6.35 7 8 9 9.52 - - - - -	28	36	48					
30AH	6 6.35 7 8 9 9.52 - - - - -	30	36	48					
32AH	6 6.35 7 8 9 9.52 - - - - -	32	38	48	55	3.5	4.5	25	25
34AH	6 6.35 7 8 9 9.52 - - - - -	34	40	48					
36AH	6 6.35 7 8 9 9.52 - - - - -	36	42	48					
38AH	6 6.35 7 8 9 9.52 - - - - -	38	44	48					
40AH	6 6.35 7 8 9 9.52 - - - - -	40	46	48					
38B	6 6.35 7 8 9 9.52 10 11 12 12.7 -	38.1	66.6		60	3	M4x10	18	25
40B	6 6.35 7 8 9 9.52 10 11 12 12.7 -	40	63		60	3	M4x10	18	25
50A	6 6.35 7 8 9 9.52 10 11 12 12.7 -	50	60		60	3	M4x10	18	25
50B	6 6.35 7 8 9 9.52 10 11 12 12.7 14	50	65		60	3	M5x12	23	30
50BH	6 6.35 7 8 9 9.52 10 11 12 12.7 14	50	65		60	4	5.5	23	30
50C	6 6.35 7 8 9 9.52 10 11 12 12.7 14	50	70		60	3	M4x10	23	30
50MH	6 6.35 7 8 9 9.52 10 11 12 12.7 -	50	65		55	4	5.5	16	23
60A	6 6.35 7 8 9 9.52 10 11 12 12.7 -	60	75		63	3	M5x12	18	25
60AH	6 6.35 7 8 9 9.52 10 11 12 12.7 -	60	75		65	3	5.5	18	25
60A1	6 6.35 7 8 9 9.52 10 11 12 12.7 14	60	75		63	3	M5x12	23	30
60AH1	6 6.35 7 8 9 9.52 10 11 12 12.7 14	60	75		65	3	5.5	23	30
60B	6 6.35 7 8 9 9.52 10 11 12 12.7 14	60	85		75	3	M5x12	23	30
60C	6 6.35 7 8 9 9.52 10 11 12 12.7 14	60	90		75	3	M5x12	23	30
70A	6 6.35 7 8 9 9.52 10 11 12 12.7 14	70	85		75	3	M6x15	23	30
70B	6 6.35 7 8 9 9.52 10 11 12 12.7 14	70	90		75	3	M5x12	23	30
73A	6 6.35 7 8 9 9.52 10 11 12 12.7 14	73	98.4		85	3	M5x12	25	32
80A	6 6.35 7 8 9 9.52 10 11 12 12.7 14	80	100		85	3	M6x15	23	30

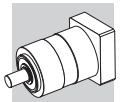

**FM**

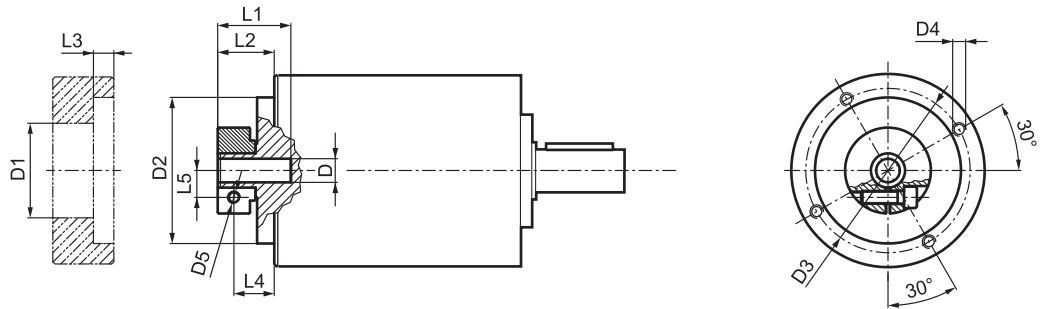

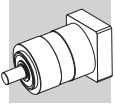

D		D1	D2	D3	D4	D5	L1	L2	L3	L4	L5
6	6.35 7	32.5	50	42.5	M4x8	M4	21.7	13.2	3	8.2	8
8	9 9.52 10	32.5	50	42.5	M4x8	M4	21.7	13.2	3	8.2	9
11	12 12.7	35.5	50	42.5	M4x8	M4	22	13.5	3	8.5	11
14		35.5	50	42.5	M4x8	M4	25	17	3	10.2	11.5

 i	$M_{n2}$	$M_{a2}$	$M_{p2}$	$n_{1 \max}$	$\varphi_S$	$\varphi_R$	$C_t$	$R_{2 \max}$	$A_{2 \max}$	$\eta$	$J_G$ [kgcm <sup>2</sup> ]	
	[Nm]	[Nm]	[Nm]	[min <sup>-1</sup> ]	[arcmin]	[arcmin]	$\frac{Nm}{arcmin}$	[N]	[N]	%	6 ... 9.52	10 ... 14
LC 050 1_3	10	16	28	4000	12'	6'	0.9	500	600	97	0.07	0.10
LC 050 1_4	12	20	30	5000	12'	6'	0.9	500	600	97	0.06	0.08
LC 050 1_5	12	20	30	5000	12'	6'	0.9	500	600	97	0.05	0.07
LC 050 1_7	12	20	30	5000	12'	6'	0.9	500	600	97	0.04	0.06
LC 050 1_9	10	16	28	6000	12'	6'	0.9	500	600	97	0.04	0.06
LC 050 2_12	12	20	30	4000	15'	8'	0.75	500	600	94	0.07	0.09
LC 050 2_15	12	20	30	4000	15'	8'	0.75	500	600	94	0.07	0.09
LC 050 2_16	12	20	30	5000	15'	8'	0.75	500	600	94	0.05	0.07
LC 050 2_20	12	20	30	5000	15'	8'	0.75	500	600	94	0.05	0.07
LC 050 2_25	12	20	30	5000	15'	8'	0.75	500	600	94	0.05	0.07
LC 050 2_28	12	20	30	5000	15'	8'	0.75	500	600	94	0.04	0.06
LC 050 2_35	12	20	30	5000	15'	8'	0.75	500	600	94	0.04	0.06
LC 050 2_36	12	20	30	6000	15'	8'	0.75	500	600	94	0.04	0.06
LC 050 2_45	12	20	30	6000	15'	8'	0.75	500	600	94	0.04	0.06
LC 050 2_81	10	16	28	6000	15'	8'	0.75	500	600	94	0.04	0.06

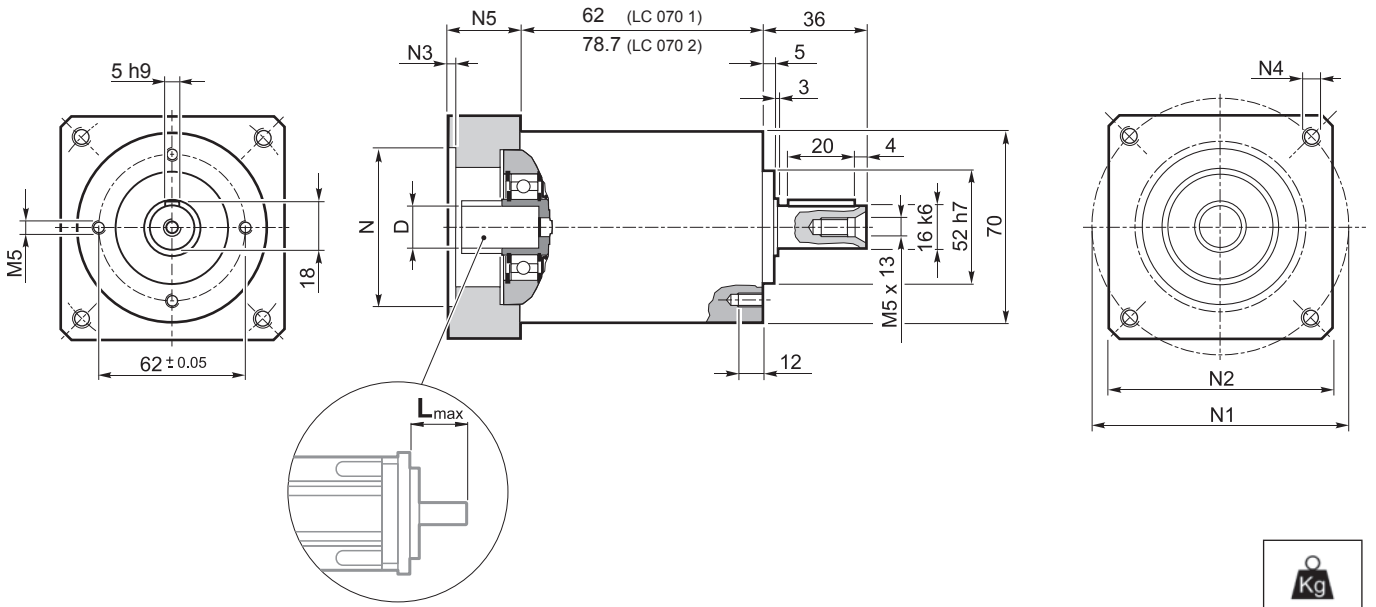

# LC 070

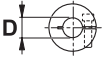

	
<b>LC 070 1</b>	2.0
<b>LC 070 2</b>	2.3

											N	N1		N2	N3	N4	N5	L <sub>max</sub>
												min	max					
<b>25AH</b>	6.35	7	8	9	9.52	-	-	-	-	-	25	39	56	65	3.5	4.5	25	25
<b>26AH</b>	6.35	7	8	9	9.52	-	-	-	-	-	26	39	56					
<b>28AH</b>	6.35	7	8	9	9.52	-	-	-	-	-	28	39	56					
<b>30AH</b>	6.35	7	8	9	9.52	-	-	-	-	-	30	39	56					
<b>32AH</b>	6.35	7	8	9	9.52	-	-	-	-	-	32	39	56					
<b>34AH</b>	6.35	7	8	9	9.52	-	-	-	-	-	34	40	56					
<b>36AH</b>	6.35	7	8	9	9.52	-	-	-	-	-	36	42	56					
<b>39AH</b>	6.35	7	8	9	9.52	-	-	-	-	-	39	45	56					
<b>40AH</b>	6.35	7	8	9	9.52	-	-	-	-	-	40	46	56					
<b>38B</b>	6.35	7	8	9	9.52	10	11	12	12.7	-	38.1	66.6	60	3	M4x10	18	25	
<b>40B</b>	6.35	7	8	9	9.52	10	11	12	12.7	-	40	63	60	3	M4x10	18	25	
<b>50A</b>	6.35	7	8	9	9.52	10	11	12	12.7	-	50	60	60	3	M4x10	18	25	
<b>50B</b>	6.35	7	8	9	9.52	10	11	12	12.7	14	50	65	60	3	M5x12	23	30	
<b>50BH</b>	6.35	7	8	9	9.52	10	11	12	12.7	14	50	65	65	3	5.5	25	32	
<b>50C</b>	6.35	7	8	9	9.52	10	11	12	12.7	14	50	70	60	3	M4x10	23	30	
<b>55MH</b>	6.35	7	8	9	9.52	10	11	12	12.7	-	55	80	65	2	5.5	16	23	
<b>60A</b>	6.35	7	8	9	9.52	10	11	12	12.7	-	60	75	63	3	M5x12	18	25	
<b>60A1</b>	6.35	7	8	9	9.52	10	11	12	12.7	14	60	75	63	3	M5x12	23	30	
<b>60B</b>	6.35	7	8	9	9.52	10	11	12	12.7	14	60	85	75	3	M5x12	23	30	
<b>60C</b>	6.35	7	8	9	9.52	10	11	12	12.7	14	60	90	75	3	M5x12	23	30	
<b>70A</b>	6.35	7	8	9	9.52	10	11	12	12.7	14	70	85	75	3	M6x15	23	30	
<b>70B</b>	6.35	7	8	9	9.52	10	11	12	12.7	14	70	90	75	3	M5x12	23	30	
<b>73A</b>	6.35	7	8	9	9.52	10	11	12	12.7	14	73	98.4	85	3	M5x12	25	32	
<b>80A</b>	6.35	7	8	9	9.52	10	11	12	12.7	14	80	100	85	3	M6x15	23	30	

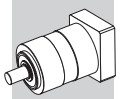

**FM**

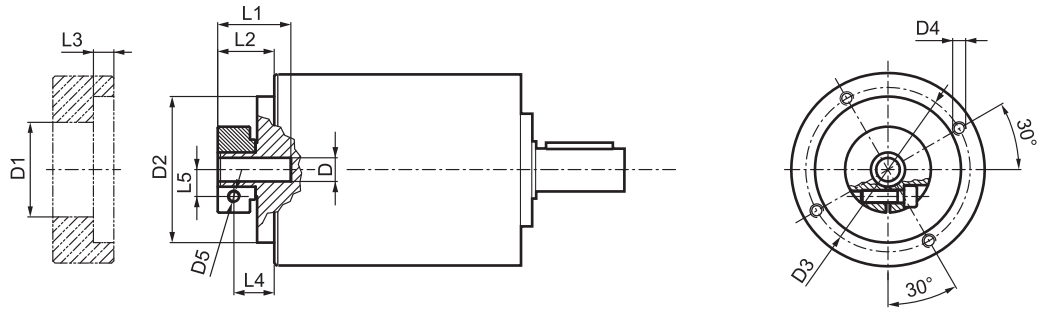

D		D1	D2	D3	D4	D5	L1	L2	L3	L4	L5
6.35	7	32.5	50	42.5	M4x8	M4	21.7	13.2	3	8.2	8
8	9 9.52 10	32.5	50	42.5	M4x8	M4	21.7	13.2	3	8.2	9
11	12 12.7	35.5	50	42.5	M4x8	M4	22	13.5	3	8.5	11
14		35.5	50	42.5	M4x8	M4	25	17	3	10.2	11.5

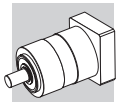

i	M <sub>n 2</sub> [Nm]	M <sub>a 2</sub> [Nm]	M <sub>p 2</sub> [Nm]	n <sub>1 max</sub> [min <sup>-1</sup> ]	φ		C <sub>t</sub> [ $\frac{Nm}{arcmin}$ ]	R <sub>2 max</sub> [N]	A <sub>2 max</sub> [N]	η %	J <sub>G</sub> [kgcm <sup>2</sup> ]	
					φ <sub>S</sub> [arcmin]	φ <sub>R</sub> [arcmin]					6.35 ... 9.52	10 ... 14
LC 070 1_3	18	30	60	4000	12'	6'	3	1300	1400	97	0.12	0.14
LC 070 1_4	25	35	70	5000	12'	6'	3	1300	1400	97	0.08	0.10
LC 070 1_5	25	35	70	5000	12'	6'	3	1300	1400	97	0.06	0.09
LC 070 1_7	25	35	70	5000	12'	6'	3	1300	1400	97	0.05	0.07
LC 070 1_10	18	30	60	6000	12'	6'	3	1300	1400	97	0.04	0.06
LC 070 2_9	18	30	60	4000	15'	8'	2.5	1300	1400	94	0.11	0.13
LC 070 2_12	25	35	70	4000	15'	8'	2.5	1300	1400	94	0.10	0.13
LC 070 2_15	25	35	70	4000	15'	8'	2.5	1300	1400	94	0.10	0.12
LC 070 2_16	25	35	70	5000	15'	8'	2.5	1300	1400	94	0.07	0.09
LC 070 2_20	25	35	70	5000	15'	8'	2.5	1300	1400	94	0.06	0.08
LC 070 2_25	25	35	70	5000	15'	8'	2.5	1300	1400	94	0.06	0.08
LC 070 2_28	25	35	70	5000	15'	8'	2.5	1300	1400	94	0.05	0.07
LC 070 2_30	18	30	60	6000	15'	8'	2.5	1300	1400	94	0.04	0.06
LC 070 2_35	25	35	70	5000	15'	8'	2.5	1300	1400	94	0.05	0.07
LC 070 2_40	25	35	70	6000	15'	8'	2.5	1300	1400	94	0.04	0.06
LC 070 2_50	25	35	70	6000	15'	8'	2.5	1300	1400	94	0.04	0.06
LC 070 2_70	25	35	70	6000	15'	8'	2.5	1300	1400	94	0.04	0.06
LC 070 2_100	18	30	60	6000	15'	8'	2.5	1300	1400	94	0.04	0.06

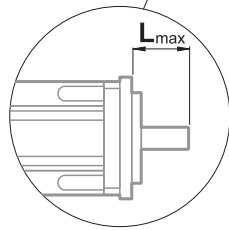
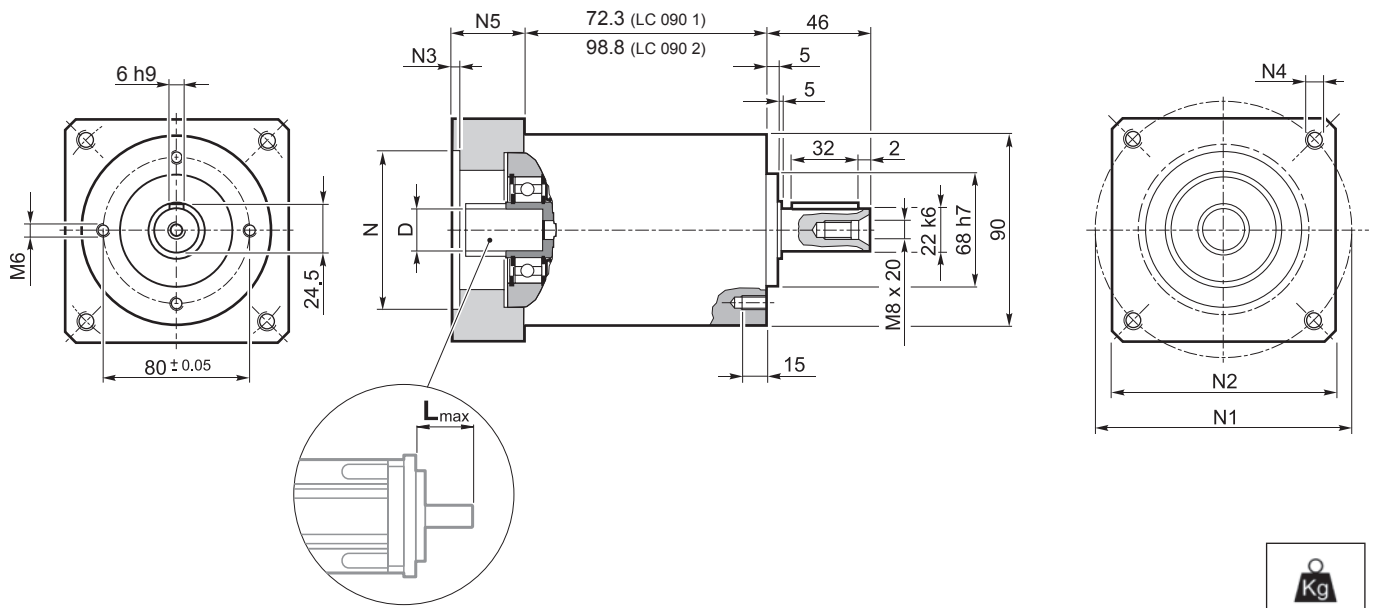

# LC 090



	Kg
<b>LC 090 1</b>	4.2
<b>LC 090 2</b>	5.3

												N	N1	N2	N3	N4	N5	L <sub>max</sub>
	9	9.52	11	12	12.7	14	-	-	-	-	-							
<b>40B1</b>	9	9.52	11	12	12.7	14	-	-	-	-	-	40	63	80	4	M4x10	34	40
<b>45A</b>	9	9.52	11	12	12.7	-	-	-	-	-	-	45	63	80	4	M4x10	34	40
<b>50B1</b>	9	9.52	11	12	12.7	14	-	-	-	-	-	50	65	80	4	M5x16	34	40
<b>50BH1</b>	9	9.52	11	12	12.7	14	-	-	-	-	-	50	65	80	4	5.5	34	40
<b>50C1</b>	9	9.52	11	12	12.7	14	-	-	-	-	-	50	70	80	4	M4x10	34	40
<b>50D</b>	9	9.52	11	12	12.7	14	-	-	-	-	-	50	95	80	4	M6x10	34	40
<b>55A</b>	9	9.52	11	12	12.7	14	15.875	16	17	19	19.05	55.5	125.7	105	4	M6x16	34	40
<b>60A2</b>	9	9.52	11	12	12.7	14	-	-	-	-	-	60	75	80	4	M5x16	34	40
<b>60AH2</b>	9	9.52	11	12	12.7	14	-	-	-	-	-	60	75	90	4	5.5	34	40
<b>60B1</b>	9	9.52	11	12	12.7	14	15.875	16	-	-	-	60	85	80	4	M5x16	34	40
<b>60C1</b>	9	9.52	11	12	12.7	14	15.875	16	-	-	-	60	90	80	4	M5x16	34	40
<b>70A1</b>	9	9.52	11	12	12.7	14	15.875	16	17	19	19.05	70	85	80	4	M6x20	34	40
<b>70AH1</b>	9	9.52	11	12	12.7	14	15.875	16	17	19	19.05	70	85	90	4	6.5	34	40
<b>70B1</b>	9	9.52	11	12	12.7	14	15.875	16	17	19	19.05	70	90	80	4	M5x16	34	40
<b>73A1</b>	9	9.52	11	12	12.7	14	-	-	-	-	-	73	98.4	85	4	M5x16	34	40
<b>80A1</b>	9	9.52	11	12	12.7	14	15.875	16	17	19	19.05	80	100	90	4	M6x16	34	40
<b>95A</b>	9	9.52	11	12	12.7	14	15.875	16	17	19	19.05	95	115	100	4	M8x20	34	40
<b>95B</b>	9	9.52	11	12	12.7	14	15.875	16	17	19	19.05	95	130	115	4	M8x20	34	40
<b>110A</b>	9	9.52	11	12	12.7	14	15.875	16	17	19	19.05	110	130	115	4	M8x20	34	40
<b>110B</b>	9	9.52	11	12	12.7	14	15.875	16	17	19	19.05	110	145	120	6.5	M8x20	44	50
<b>110B1</b>	9	9.52	11	12	12.7	14	15.875	16	17	19	19.05	110	145	120	6.5	M8x20	54	60



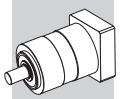

**FM**

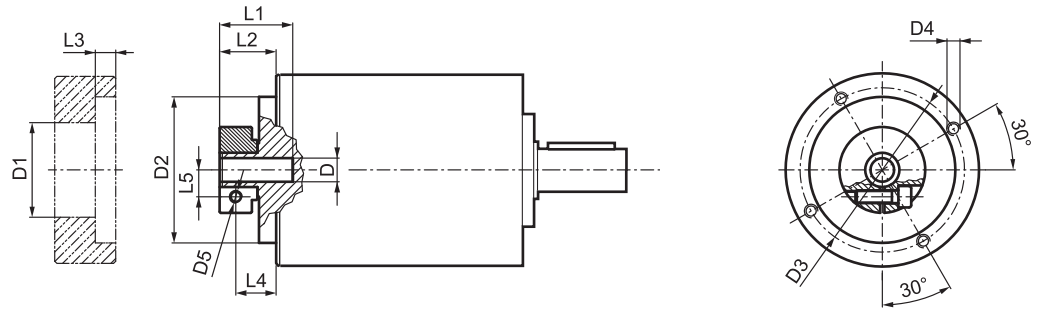

				D1	D2	D3	D4	D5	L1	L2	L3	L4	L5
9	9.52			38	68	76.5	M6x10	M6	34	26.8	9.5	18.8	10.5
11	12	12.7		43	68	76.5	M6x10	M6	34	26.8	9.5	18.8	12.5
14	15.875	16	17	48	68	76.5	M6x10	M6	34	26.8	9.5	18.8	14.5
19	19.05			51	68	76.5	M6x10	M6	34	26.8	9.5	18.8	16.5

	i	M <sub>n 2</sub>	M <sub>a 2</sub>	M <sub>p 2</sub>	n <sub>1 max</sub>	φ <sub>S</sub>	φ <sub>R</sub>	C <sub>t</sub>	R <sub>2 max</sub>	A <sub>2 max</sub>	η	J <sub>G</sub> [kgcm <sup>2</sup> ]	
		[Nm]	[Nm]	[Nm]	[min <sup>-1</sup> ]	[arcmin]	[Nm/arcmin]	[N]	[N]	%	9 ... 12.7	14 ... 19.05	
LC 090 1_3		37	70	150	3500	12'	6'	7	2200	1900	97	0.62	0.77
LC 090 1_4		43	80	160	4500	12'	6'	7	2200	1900	97	0.41	0.55
LC 090 1_5		43	80	160	4500	12'	6'	7	2200	1900	97	0.33	0.47
LC 090 1_7		43	80	160	4500	12'	6'	7	2200	1900	97	0.26	0.40
LC 090 1_10		37	70	150	6000	12'	6'	7	2200	1900	97	0.21	0.35
LC 090 2_9		37	70	150	3500	15'	8'	5.9	2200	1900	94	0.47	0.61
LC 090 2_12		43	80	160	3500	15'	8'	5.9	2200	1900	94	0.44	0.58
LC 090 2_15		43	80	160	3500	15'	8'	5.9	2200	1900	94	0.43	0.57
LC 090 2_16		43	80	160	4500	15'	8'	5.9	2200	1900	94	0.31	0.45
LC 090 2_20		43	80	160	4500	15'	8'	5.9	2200	1900	94	0.26	0.40
LC 090 2_25		43	80	160	4500	15'	8'	5.9	2200	1900	94	0.26	0.40
LC 090 2_28		43	80	160	4500	15'	8'	5.9	2200	1900	94	0.22	0.36
LC 090 2_30		37	70	150	6000	15'	8'	5.9	2200	1900	94	0.20	0.34
LC 090 2_35		43	80	160	4500	15'	8'	5.9	2200	1900	94	0.22	0.36
LC 090 2_40		43	80	160	6000	15'	8'	5.9	2200	1900	94	0.20	0.34
LC 090 2_50		43	80	160	6000	15'	8'	5.9	2200	1900	94	0.20	0.34
LC 090 2_70		43	80	160	6000	15'	8'	5.9	2200	1900	94	0.20	0.34
LC 090 2_100		37	70	150	6000	15'	8'	5.9	2200	1900	94	0.19	0.34

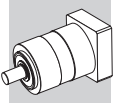

# LC 120

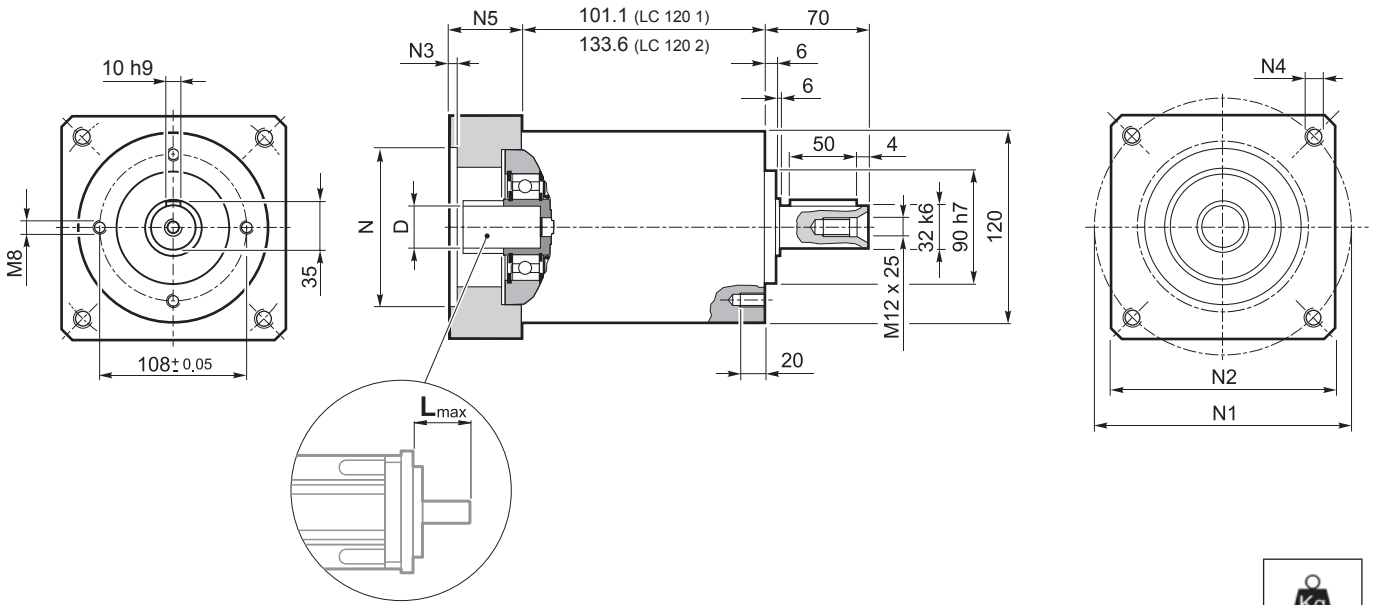

	
LC 120 1	9.6
LC 120 2	12.1

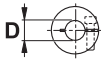
									N	N1	N2	N3	N4	N5	L <sub>max</sub>	
<b>50D</b>	14	15	15.875	16	19	-	-	-	-	50	95	100	5	M6x14	28	40
<b>55A</b>	14	15	15.875	16	19	-	-	-	-	55.5	125.7	105	5	M6x16	28	40
<b>60A2</b>	14	15	15.875	16	19	-	-	-	-	60	75	100	5	M5x14	28	40
<b>60AH2</b>	14	15	15.875	16	19	-	-	-	-	60	75	100	5	6.5	33	40
<b>60B1</b>	14	15	15.875	16	19	-	-	-	-	60	85	100	6.5	M5x14	28	40
<b>70A1</b>	14	15	15.875	16	19	-	-	-	-	70	85	100	5	M6x14	28	40
<b>70AH1</b>	14	15	15.875	16	19	-	-	-	-	70	85	100	5	6	33	40
<b>70B1</b>	14	15	15.875	16	19	-	-	-	-	70	90	100	5	M5x12	28	40
<b>80A1</b>	14	15	15.875	16	19	-	-	-	-	80	100	100	5	M6x16	28	40
<b>80AH1</b>	14	15	15.875	16	19	-	-	-	-	80	100	100	5	6.5	28	40
<b>95A</b>	14	15	15.875	16	19	-	-	-	-	95	115	100	5	M8x18	28	40
<b>95A1</b>	14	15	15.875	16	19	22	24	-	-	95	115	100	5	M8x18	38	50
<b>95B</b>	14	15	15.875	16	19	-	-	-	-	95	130	115	5	M8x18	28	40
<b>110A</b>	14	15	15.875	16	19	-	-	-	-	110	130	115	5	M8x18	28	40
<b>110A1</b>	14	15	15.875	16	19	22	24	-	-	110	130	115	6.5	M8x20	38	50
<b>110B</b>	14	15	15.875	16	19	22	24	-	-	110	145	120	6.5	M8x20	38	50
<b>110B1</b>	14	15	15.875	16	19	22	24	28	-	110	145	120	6.5	M8x20	48	60
<b>130A</b>	14	15	15.875	16	19	22	24	-	-	130	165	140	6.5	M10x20	38	50
<b>130A1</b>	14	15	15.875	16	19	22	24	28	32	130	165	140	6.5	M10x25	48	60

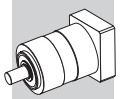

**FM**

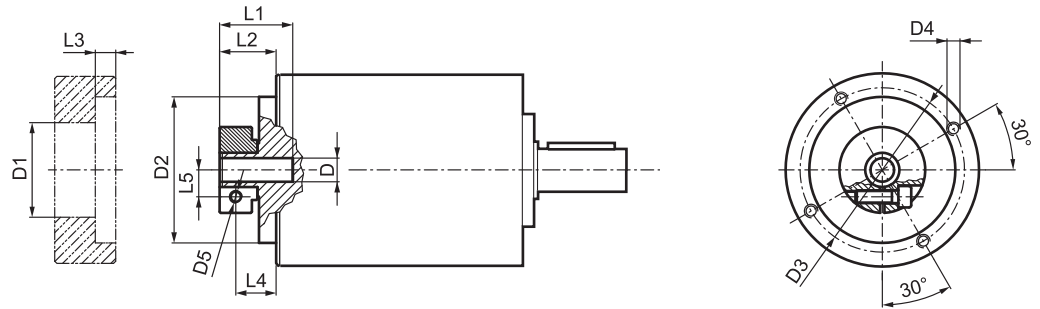

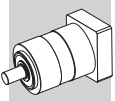

D	D		D1	D2	D3	D4	D5	L1	L2	L3	L4	L5	
	15	15.875											16
14	15	15.875	16	48	90	98	M6x15	M6	33.5	20	7.6	12.5	14.5
19				51	90	98	M6x15	M6	33.5	20	7.6	12.5	16.5
22	24			56.5	90	98	M6x15	M6	36.5	23	7.6	14	19
28				67	90	98	M6x15	M8	36.5	23	7.6	14	22.5
32				71	90	98	M6x15	M8	38	24.5	7.6	15.5	24.5

i	M <sub>n 2</sub> [Nm]	M <sub>a 2</sub> [Nm]	M <sub>p 2</sub> [Nm]	n <sub>1 max</sub> [min <sup>-1</sup> ]	φ <sub>S</sub> [arcmin]	φ <sub>R</sub> [arcmin]	C <sub>t</sub> [Nm/arcmin]	R <sub>2 max</sub> [N]	A <sub>2 max</sub> [N]	η %	J <sub>G</sub> [kgcm <sup>2</sup> ]		
											14 ... 19	22 ; 24	28 ; 32
LC 120 1_3	95	160	300	3500	12'	6'	22	3500	3000	97	2.17	2.77	3.13
LC 120 1_4	110	190	360	4500	12'	6'	22	3500	3000	97	1.30	1.89	2.26
LC 120 1_5	110	190	360	4500	12'	6'	22	3500	3000	97	0.96	1.56	1.92
LC 120 1_7	110	190	360	4500	12'	6'	22	3500	3000	97	0.66	1.26	1.62
LC 120 1_10	95	160	300	5000	12'	6'	22	3500	3000	97	0.49	1.09	1.45
LC 120 2_9	95	160	300	3500	15'	8'	20.5	3500	3000	94	1.61	2.20	2.57
LC 120 2_12	110	190	360	3500	15'	8'	20.5	3500	3000	94	1.51	2.10	2.47
LC 120 2_15	110	190	360	3500	15'	8'	20.5	3500	3000	94	1.47	2.06	2.43
LC 120 2_16	110	190	360	4500	15'	8'	20.5	3500	3000	94	0.92	1.52	1.88
LC 120 2_20	110	190	360	4500	15'	8'	20.5	3500	3000	94	0.90	1.50	1.86
LC 120 2_25	110	190	360	4500	15'	8'	20.5	3500	3000	94	0.71	1.30	1.67
LC 120 2_28	110	190	360	4500	15'	8'	20.5	3500	3000	94	0.54	1.13	1.50
LC 120 2_30	95	160	300	5000	15'	8'	20.5	3500	3000	94	0.44	1.04	1.40
LC 120 2_35	110	190	360	4500	15'	8'	20.5	3500	3000	94	0.53	1.13	1.49
LC 120 2_40	110	190	360	5000	15'	8'	20.5	3500	3000	94	0.43	1.03	1.39
LC 120 2_50	110	190	360	5000	15'	8'	20.5	3500	3000	94	0.43	1.02	1.39
LC 120 2_70	110	190	360	5000	15'	8'	20.5	3500	3000	94	0.42	1.02	1.38
LC 120 2_100	95	160	300	5000	15'	8'	20.5	3500	3000	94	0.42	1.02	1.38

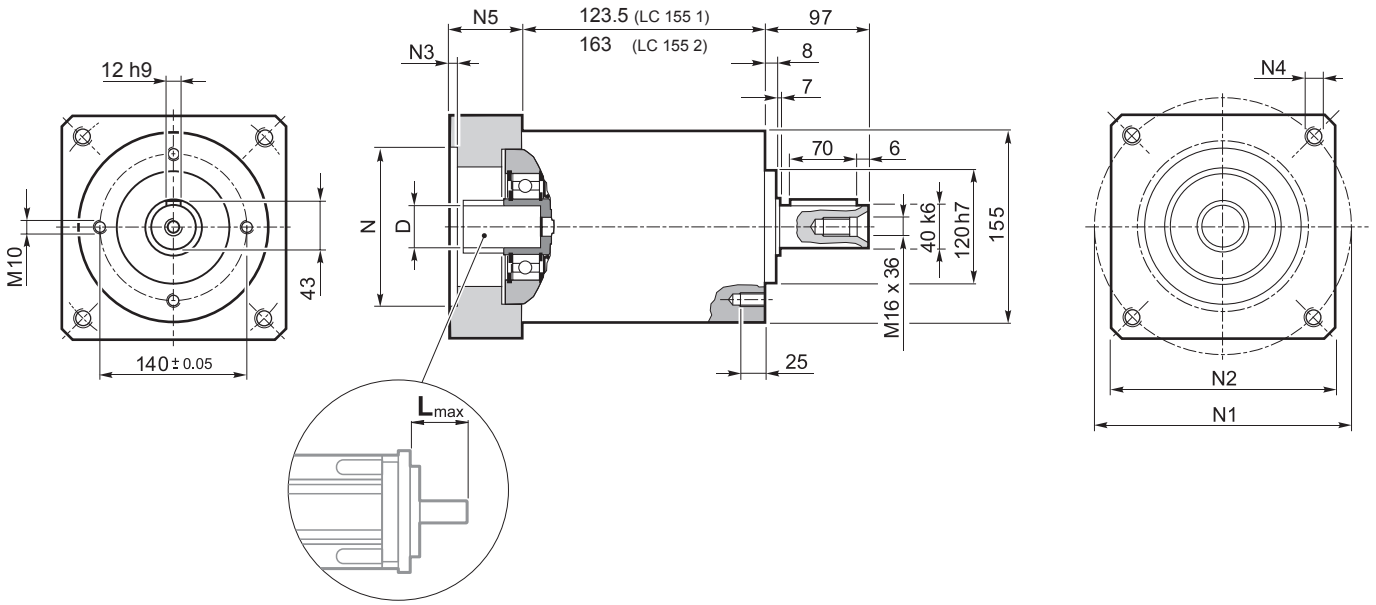

# LC 155

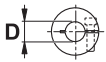

	 Kg
<b>LC 155 1</b>	19.3
<b>LC 155 2</b>	24.3

								N	N1	N2	N3	N4	N5	L <sub>max</sub>
<b>55A1</b>	19	-	-	-	-	-	-	55.5	125.7	130	4	M6x15	39.5	50
<b>80A2</b>	19	-	-	-	-	-	-	80	100	130	4	M6x15	39.5	50
<b>95A1</b>	19	22	24	-	-	-	-	95	115	130	4	M8x20	39.5	50
<b>110A1</b>	19	22	24	-	-	-	-	110	130	130	4	M8x20	39.5	50
<b>110B1</b>	19	22	24	-	-	-	-	110	145	130	6.5	M8x20	49.5	60
<b>114A</b>	19	22	24	28	32	35	38	114.3	200	170	5.5	M12x25	69.5	80
<b>130A</b>	19	22	24	-	-	-	-	130	165	140	4	M10x20	39.5	50
<b>130A1</b>	19	22	24	28	32	-	-	130	165	140	4	M10x20	49.5	60
<b>180A</b>	19	22	24	28	32	-	-	180	215	190	5.5	M14x25	49.5	60
<b>180A1</b>	19	22	24	28	32	35	38	180	215	190	5.5	M14x25	69.5	80

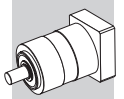

**FM**

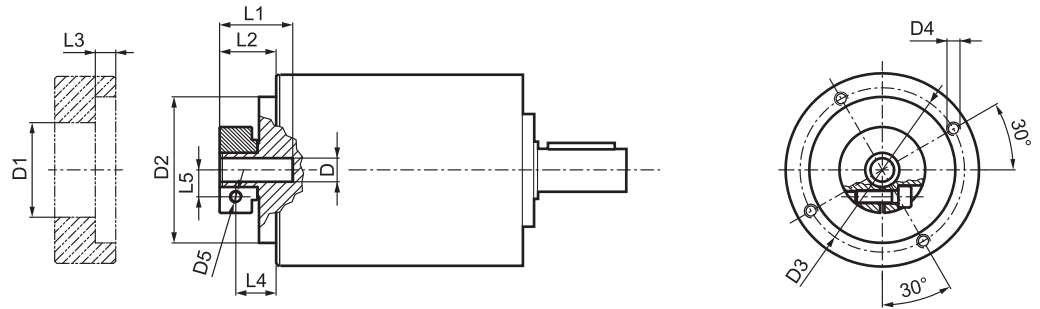

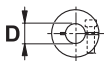
	D1	D2	D3	D4	D5	L1	L2	L3	L4	L5
19	51	113	125.5	M8x15	M6	40	27.5	6	20	16.5
22 24	56.5	113	125.5	M8x15	M6	41	28.5	6	19.5	19
28	67	113	125.5	M8x15	M8	41	28.5	6	19.5	22.5
32	71	113	125.5	M8x15	M8	41	28.5	6	18.5	24.5
35	73	113	125.5	M8x15	M8	50	37.5	11.25	26	26
38	77.5	113	125.5	M8x15	M8	50	37.5	11.25	26	28

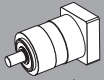
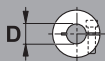
	M <sub>n 2</sub> [Nm]	M <sub>a 2</sub> [Nm]	M <sub>p 2</sub> [Nm]	n <sub>1 max</sub> [min <sup>-1</sup> ]	φ <sub>s</sub>		C <sub>t</sub> [ $\frac{Nm}{arcmin}$ ]	R <sub>2 max</sub> [N]	A <sub>2 max</sub> [N]	η %	J <sub>G</sub> [kgcm <sup>2</sup> ]			
					φ <sub>R</sub>						19	22 ; 24	28 ; 32	35 ; 38
LC 155 1 _ 3	250	380	600	3600	12'	6'	43.0	6000	5000	97	7.99	8.19	8.54	9.90
LC 155 1 _ 4	300	450	700	3600	12'	6'	43.0	6000	5000	97	4.66	4.87	5.23	6.57
LC 155 1 _ 5	300	450	900	3600	12'	6'	43.0	6000	5000	97	3.32	3.53	3.88	5.23
LC 155 1 _ 7	300	450	900	3600	12'	6'	43.0	6000	5000	97	2.14	2.35	2.70	4.05
LC 155 1 _ 10	230	350	750	3600	12'	6'	43.0	6000	5000	97	1.45	1.66	2.01	3.36
LC 155 2 _ 9	250	380	600	3600	15'	8'	37.5	6000	5000	94	5.30	5.51	5.86	7.21
LC 155 2 _ 12	300	450	700	3600	15'	8'	37.5	6000	5000	94	4.93	5.14	5.49	6.84
LC 155 2 _ 15	300	450	900	3600	15'	8'	37.5	6000	5000	94	4.79	4.99	5.34	6.70
LC 155 2 _ 16	300	450	700	3600	15'	8'	37.5	6000	5000	94	2.97	3.18	3.53	4.88
LC 155 2 _ 20	300	450	900	3600	15'	8'	37.5	6000	5000	94	2.23	2.44	2.79	4.14
LC 155 2 _ 25	300	450	900	3600	15'	8'	37.5	6000	5000	94	2.18	2.39	2.74	4.09
LC 155 2 _ 28	300	450	900	3600	15'	8'	37.5	6000	5000	94	1.58	1.79	2.14	3.49
LC 155 2 _ 30	250	380	600	3600	15'	8'	37.5	6000	5000	94	1.23	1.44	1.79	3.14
LC 155 2 _ 35	300	450	900	3600	15'	8'	37.5	6000	5000	94	1.55	1.76	2.11	3.46
LC 155 2 _ 40	300	450	700	3600	15'	8'	37.5	6000	5000	94	1.20	1.41	1.76	3.11
LC 155 2 _ 50	300	450	900	3600	15'	8'	37.5	6000	5000	94	1.19	1.39	1.74	3.10
LC 155 2 _ 70	300	450	900	3600	15'	8'	37.5	6000	5000	94	1.17	1.38	1.73	3.08
LC 155 2 _ 100	230	350	750	3600	15'	8'	37.5	6000	5000	94	1.17	1.38	1.73	3.08

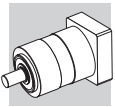

## INDEX OF REVISIONS (R)

R2	
	Description
4	Sect 1.2 "Selecting the gear unit": - new selection procedure
6	Sect. 1.3 "Service life of bearings": - new calculation procedure
8	Sect 2 "Features of LC series": - information about oil seals newly added
9	Sect 3 "Ordering code": - ordering code for keyed output shaft (KE) newly added
10 ... 19	Sect. 4 "Dimensions and technical specifications": - new designation of motor adapters - updated weight of gear units - updated technical specifications - updated dimensions

120208

This publication supersedes and replaces any previous edition and revision. We reserve the right to implement modifications without notice. This catalogue cannot be reproduced, even partially, without prior consent.





Bonfiglioli has been designing and developing innovative and reliable power transmission and control solutions for industry, mobile machinery and renewable energy applications since 1956.